



# RUBBER SUSPENSION ELEMENTS

## Torsion-elastic spring assemblies for contemporary engineering and design

- Pendulum suspensions for unbalanced motors
- Torque supports for gear motors
- Torsional springs for continuous surface pressure
- Fully customized rubber suspensions available in exclusive design upon request
- Torsion elastic mounts offering constant pressure on workparts (infeed devices)
- Energy absorbing impact suspensions

### Product advantages:



long service life

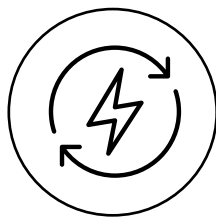



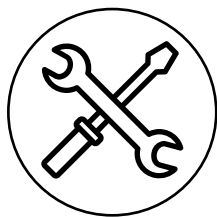









energy-saving

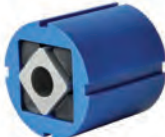

easy to install

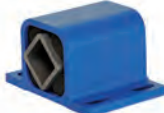
# Selection table rubber suspension elements (Rubmix 10)

2

		Type inner square			
		A Aluminium profile (from size 60 in steel)	C Aluminium profile	S Steel tube for plug-in connection	
		Illustration			Page
Type housing	<b>DR</b> Steel tube	<b>DR-A</b> 	<b>DR-C</b> 	<b>DR-S</b> 	2.4– 2.6
	<b>DK</b> Aluminium profile	<b>DK-A</b> 	<b>DK-C</b> 	<b>DK-S</b> 	2.8– 2.9
	<b>DW</b> Aluminium profile (from size 60 steel welded construction)	<b>DW-A 15 to 50</b> 	<b>DW-C 15 to 50</b> 	<b>DW-S 15 to 50</b> 	2.11– 2.14
		<b>DW-A 60 to 100</b> 			
	<b>DO</b> Aluminium profile	<b>DO-A</b> 	<b>DO-C</b> 	<b>DO-S</b> 	2.15

- DK-C, DO-C and DO-S only on request.
- Note about accessories (BR, BK, WS) on pages 2.7, 2.10, 2.16.
- Aluminium profiles: extruded profiles, seawater resistant (DIN 1725).
- Blue paint: thickness 40–80 µm.
- Inner steel tube type S: electrodeposited galvanic zinc coating.
- Mounting bolts: strength class of 8.8.
- Welding heat will affect or destroy the rubber inserts – ask for customized elements.
- Stainless steel, zinc-plated versions or special paintings upon request.

# List of torque and loads

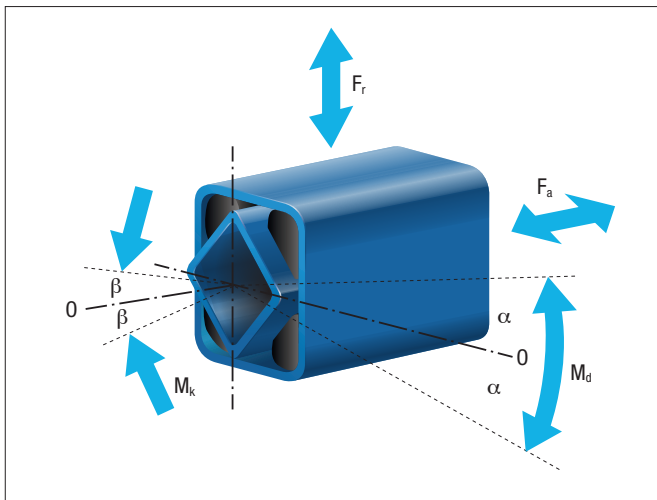

The values stated in the below mentioned list have been measured statically and are valid for the standard rubber quality «Rubmix 10». Intermediate values can be interpolated.

By applications with combined dynamic forces and high angles of oscillation please see chapter 7 «Technology» or contact ROSTA.

Element			Torque						Cardanic	Radial		Axial	
Nominal size	x	Length	M <sub>d</sub> [Nm] angle ±α°						M <sub>k</sub> [Nm] angle ±β°	Deflection ± s <sub>r</sub> [mm]	Load F <sub>r</sub> [N]	Deflection ± s <sub>a</sub> [mm]	Load F <sub>a</sub> [N]
			5°	10°	15°	20°	25°	30°	1°				
11	x	20	0.4	1.0	1.6	2.4	3.5	4.8	0.4	0.25	200	0.25	60
11	x	30	0.5	1.4	2.4	3.7	5.2	7.2	1.1	0.25	340	0.25	80
11	x	50	0.8	2.4	4.1	6.1	8.6	12.0	5.6	0.25	600	0.25	150
15	x	25	0.7	1.6	2.6	4.0	5.7	8.2	0.6	0.25	200	0.25	70
15	x	40	1.1	2.5	4.2	6.4	9.2	13.2	2.0	0.25	300	0.25	100
15	x	60	1.6	3.8	6.3	9.6	13.8	19.8	5.5	0.25	500	0.25	160
18	x	30	1.9	4.5	7.5	11.0	15.0	20.6	1.6	0.25	400	0.25	80
18	x	50	3.2	7.5	12.5	18.3	25.0	34.4	7.0	0.25	700	0.25	160
18	x	80	5.1	12.0	20.0	29.3	40.0	55.0	28.0	0.25	1000	0.25	300
27	x	40	4.7	10.7	17.5	26.9	39.5	57.0	3.8	0.5	800	0.5	200
27	x	60	7.0	16.0	26.3	40.3	59.3	85.5	11.5	0.5	1300	0.5	300
27	x	100	11.7	26.7	43.8	67.2	98.8	142.5	48.0	0.5	2400	0.5	600
38	x	60	13.0	30.4	50.6	78.0	113.0	162.0	11.4	0.5	1500	0.5	300
38	x	80	17.3	40.5	67.5	104.0	151.0	216.0	24.7	0.5	2000	0.5	500
38	x	120	26.0	60.8	101.2	156.0	226.0	324.0	76.0	0.5	3000	0.5	600
45	x	80	27.6	62.4	104.0	160.0	222.0	320.0	28.0	0.5	1900	0.5	560
45	x	100	34.5	78.0	130.0	200.0	278.0	400.0	54.0	0.5	3000	0.5	700
45	x	150	51.8	117.0	195.0	300.0	420.0	600.0	140.0	0.5	4800	0.5	1000
50	x	120	51	133	250	395	570	780	80	0.5	2800	0.5	800
50	x	160	77	197	363	570	820	1115	145	0.5	4500	0.5	950
50	x	200	102	260	475	745	1070	1450	250	0.5	6300	0.5	1100
50	x	300	150	385	700	1100	1590	2160	1200	0.5	8600	0.5	2200
60	x	150	75	170	300	460	700	1010	90	1.0	5400	1.0	1600
60	x	200	95	220	385	610	930	1380	250	1.0	7200	1.0	2200
60	x	300	140	365	630	995	1550	2240	900	1.0	9400	1.0	3200
70	x	200	140	380	650	1040	1490	2120	280	1.0	9000	1.0	2200
70	x	300	190	525	910	1470	2160	3150	1200	1.0	12000	1.0	3600
70	x	400	250	765	1315	2160	3175	4750	2200	1.0	14000	1.0	4000
80	x	200	200	500	850	1300	1900	2700	680	1.0	10000	1.0	2500
80	x	300	300	800	1300	2000	2900	4100	1500	1.0	15000	1.0	3800
80	x	400	400	1060	1800	2800	3900	5600	4600	1.0	19000	1.0	4700
100	x	250	400	1080	1800	2800	4100	6300	1200	1.0	15000	1.0	3200
100	x	400	640	1700	2900	4500	6600	10000	4300	1.0	28000	1.0	5800
100	x	500	800	2160	3600	5600	8200	12000	8000	1.0	38000	1.0	7500

# Rubber Suspension Element

## DR-A

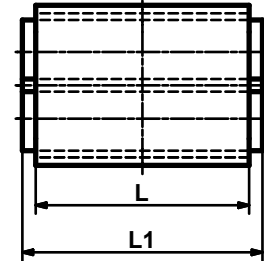
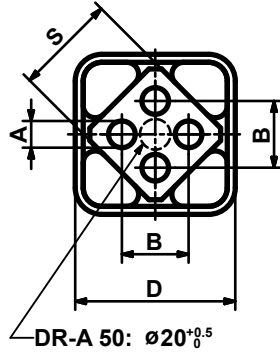

Part no.	Type	$\varnothing A$	B	$\square D$	$\square S$	L	L1	Weight [kg]
01 011 001	DR-A 15 × 25	$5^{+0.5}_0$	$10 \pm 0.2$	$27^{+0.4}_0$	15	25	$30^{+0}_-0.3$	0.06
01 011 002	DR-A 15 × 40	$5^{+0.5}_0$	$10 \pm 0.2$	$27^{+0.4}_0$	15	40	$45^{+0}_-0.3$	0.10
01 011 003	DR-A 15 × 60	$5^{+0.5}_0$	$10 \pm 0.2$	$27^{+0.4}_0$	15	60	$65^{+0}_-0.3$	0.15
01 011 004	DR-A 18 × 30	$6^{+0.5}_0$	$12 \pm 0.3$	$32^{+0.3}_{-0.1}$	18	30	$35^{+0}_-0.3$	0.10
01 011 005	DR-A 18 × 50	$6^{+0.5}_0$	$12 \pm 0.3$	$32^{+0.3}_{-0.1}$	18	50	$55^{+0}_-0.3$	0.16
01 011 006	DR-A 18 × 80	$6^{+0.5}_0$	$12 \pm 0.3$	$32^{+0.3}_{-0.1}$	18	80	$85^{+0}_-0.3$	0.26
01 011 007	DR-A 27 × 40	$8^{+0.5}_0$	$20 \pm 0.4$	$45^{+0.4}_0$	27	40	$45^{+0}_-0.3$	0.24
01 011 008	DR-A 27 × 60	$8^{+0.5}_0$	$20 \pm 0.4$	$45^{+0.4}_0$	27	60	$65^{+0}_-0.3$	0.36
01 011 009	DR-A 27 × 100	$8^{+0.5}_0$	$20 \pm 0.4$	$45^{+0.4}_0$	27	100	$105^{+0}_-0.3$	0.60
01 011 010	DR-A 38 × 60	$10^{+0.5}_0$	$25 \pm 0.4$	$60^{+0.3}_{-0.2}$	38	60	$70^{+0}_-0.3$	0.57
01 011 011	DR-A 38 × 80	$10^{+0.5}_0$	$25 \pm 0.4$	$60^{+0.3}_{-0.2}$	38	80	$90^{+0}_-0.3$	0.75
01 011 012	DR-A 38 × 120	$10^{+0.5}_0$	$25 \pm 0.4$	$60^{+0.3}_{-0.2}$	38	120	$130^{+0}_-0.3$	1.11
01 011 023	DR-A 45 × 80	$12^{+0.5}_0$	$35 \pm 0.5$	$75^{+0.3}_{-0.2}$	45	80	$90^{+0}_-0.3$	1.26
01 011 024	DR-A 45 × 100	$12^{+0.5}_0$	$35 \pm 0.5$	$75^{+0.3}_{-0.2}$	45	100	$110^{+0}_-0.3$	1.56
01 011 025	DR-A 45 × 150	$12^{+0.5}_0$	$35 \pm 0.5$	$75^{+0.3}_{-0.2}$	45	150	$160^{+0}_-0.3$	2.32
01 011 026	DR-A 50 × 120	M12 × 40	$40 \pm 0.5$	$80^{+0.3}_{-0.2}$	50	120	$130^{+0}_-0.3$	2.06
01 011 027	DR-A 50 × 200	M12 × 40	$40 \pm 0.5$	$80^{+0.3}_{-0.2}$	50	200	$210^{+0}_-0.3$	3.42
01 011 028	DR-A 50 × 300	M12 × 40	$40 \pm 0.5$	$80^{+0.3}_{-0.2}$	50	300	$310^{+0}_-0.3$	5.11

List of torque and loads on page 2.3.

If no other units are specified, the numbers given are in mm.



# Rubber Suspension Element

## DR-C

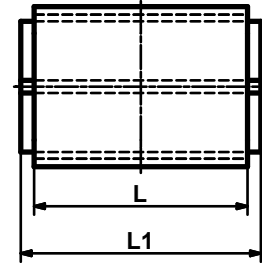
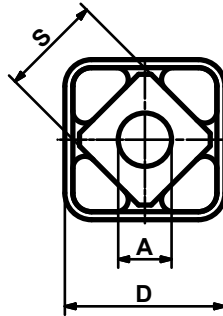

2

Part no.	Type	$\varnothing A$	B	$\square D$	$\square S$	L	L1	Weight [kg]
01 031 010	DR-C 15 × 25	10 <sup>+0.4</sup> <sub>-0.2</sub>	10 ±0.2	27 <sup>+0.4</sup> <sub>0</sub>	15	25	30 <sup>0</sup> <sub>-0.3</sub>	0.06
01 031 011	DR-C 15 × 40	10 <sup>+0.4</sup> <sub>-0.2</sub>	10 ±0.2	27 <sup>+0.4</sup> <sub>0</sub>	15	40	45 <sup>0</sup> <sub>-0.3</sub>	0.10
01 031 012	DR-C 15 × 60	10 <sup>+0.4</sup> <sub>-0.2</sub>	10 ±0.2	27 <sup>+0.4</sup> <sub>0</sub>	15	60	65 <sup>0</sup> <sub>-0.3</sub>	0.15
01 031 001	DR-C 18 × 30	13 <sup>0</sup> <sub>-0.2</sub>	12 ±0.3	32 <sup>+0.3</sup> <sub>-0.1</sub>	18	30	35 <sup>0</sup> <sub>-0.3</sub>	0.11
01 031 002	DR-C 18 × 50	13 <sup>0</sup> <sub>-0.2</sub>	12 ±0.3	32 <sup>+0.3</sup> <sub>-0.1</sub>	18	50	55 <sup>0</sup> <sub>-0.3</sub>	0.16
01 031 003	DR-C 18 × 80	13 <sup>0</sup> <sub>-0.2</sub>	12 ±0.3	32 <sup>+0.3</sup> <sub>-0.1</sub>	18	80	85 <sup>0</sup> <sub>-0.3</sub>	0.26
01 031 004	DR-C 27 × 40	16 <sup>+0.5</sup> <sub>-0.3</sub>	20 ±0.4	45 <sup>+0.4</sup> <sub>0</sub>	27	40	45 <sup>0</sup> <sub>-0.3</sub>	0.24
01 031 005	DR-C 27 × 60	16 <sup>+0.5</sup> <sub>-0.3</sub>	20 ±0.4	45 <sup>+0.4</sup> <sub>0</sub>	27	60	65 <sup>0</sup> <sub>-0.3</sub>	0.36
01 031 006	DR-C 27 × 100	16 <sup>+0.5</sup> <sub>-0.3</sub>	20 ±0.4	45 <sup>+0.4</sup> <sub>0</sub>	27	100	105 <sup>0</sup> <sub>-0.3</sub>	0.60
01 031 007	DR-C 38 × 60	20 <sup>+0.5</sup> <sub>-0.2</sub>	25 ±0.4	60 <sup>+0.3</sup> <sub>-0.2</sub>	38	60	70 <sup>0</sup> <sub>-0.3</sub>	0.57
01 031 008	DR-C 38 × 80	20 <sup>+0.5</sup> <sub>-0.2</sub>	25 ±0.4	60 <sup>+0.3</sup> <sub>-0.2</sub>	38	80	90 <sup>0</sup> <sub>-0.3</sub>	0.75
01 031 009	DR-C 38 × 120	20 <sup>+0.5</sup> <sub>-0.2</sub>	25 ±0.4	60 <sup>+0.3</sup> <sub>-0.2</sub>	38	120	130 <sup>0</sup> <sub>-0.3</sub>	1.12
01 031 023	DR-C 45 × 80	24 <sup>+0.5</sup> <sub>-0.2</sub>	35 ±0.5	75 <sup>+0.3</sup> <sub>-0.2</sub>	45	80	90 <sup>0</sup> <sub>-0.3</sub>	1.25
01 031 024	DR-C 45 × 100	24 <sup>+0.5</sup> <sub>-0.2</sub>	35 ±0.5	75 <sup>+0.3</sup> <sub>-0.2</sub>	45	100	110 <sup>0</sup> <sub>-0.3</sub>	1.53
01 031 025	DR-C 50 × 120	30 <sup>+0.5</sup> <sub>-0.2</sub>	40 ±0.5	80 <sup>+0.3</sup> <sub>-0.2</sub>	50	120	130 <sup>0</sup> <sub>-0.3</sub>	2.04
01 031 026	DR-C 50 × 200	30 <sup>+0.5</sup> <sub>-0.2</sub>	40 ±0.5	80 <sup>+0.3</sup> <sub>-0.2</sub>	50	200	210 <sup>0</sup> <sub>-0.3</sub>	3.45

List of torque and loads on page 2.3.

If no other units are specified, the numbers given are in mm.

# Rubber Suspension Element

## DR-S

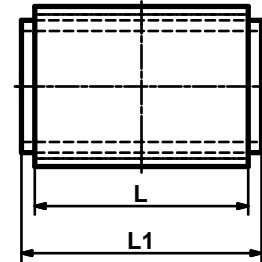
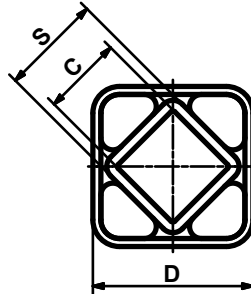
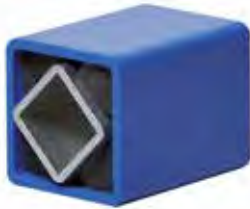

Part no.	Type	□C	□D	□S	L	L1	Weight [kg]
01 021 001	DR-S 11 × 20	8 <sup>+0.25</sup> <sub>0</sub>	20 <sup>+0.3</sup> <sub>-0.1</sub>	11	20	25 ±0.2	0.04
01 021 002	DR-S 11 × 30	8 <sup>+0.25</sup> <sub>0</sub>	20 <sup>+0.3</sup> <sub>-0.1</sub>	11	30	35 ±0.2	0.05
01 021 003	DR-S 11 × 50	8 <sup>+0.25</sup> <sub>0</sub>	20 <sup>+0.3</sup> <sub>-0.1</sub>	11	50	55 ±0.2	0.08
01 021 004	DR-S 15 × 25	11 <sup>+0.25</sup> <sub>0</sub>	27 <sup>+0.4</sup> <sub>0</sub>	15	25	30 ±0.2	0.07
01 021 005	DR-S 15 × 40	11 <sup>+0.25</sup> <sub>0</sub>	27 <sup>+0.4</sup> <sub>0</sub>	15	40	45 ±0.2	0.12
01 021 006	DR-S 15 × 60	11 <sup>+0.25</sup> <sub>0</sub>	27 <sup>+0.4</sup> <sub>0</sub>	15	60	65 ±0.2	0.17
01 021 007	DR-S 18 × 30	12 <sup>+0.25</sup> <sub>0</sub>	32 <sup>+0.3</sup> <sub>-0.1</sub>	18	30	35 ±0.2	0.13
01 021 008	DR-S 18 × 50	12 <sup>+0.25</sup> <sub>0</sub>	32 <sup>+0.3</sup> <sub>-0.1</sub>	18	50	55 ±0.2	0.21
01 021 009	DR-S 18 × 80	12 <sup>+0.25</sup> <sub>0</sub>	32 <sup>+0.3</sup> <sub>-0.1</sub>	18	80	85 ±0.2	0.33
01 021 010	DR-S 27 × 40	22 <sup>+0.25</sup> <sub>0</sub>	45 <sup>+0.4</sup> <sub>0</sub>	27	40	45 ±0.2	0.26
01 021 011	DR-S 27 × 60	22 <sup>+0.25</sup> <sub>0</sub>	45 <sup>+0.4</sup> <sub>0</sub>	27	60	65 ±0.2	0.39
01 021 012	DR-S 27 × 100	22 <sup>+0.25</sup> <sub>0</sub>	45 <sup>+0.4</sup> <sub>0</sub>	27	100	105 ±0.2	0.65
01 021 013	DR-S 38 × 60	30 <sup>+0.25</sup> <sub>0</sub>	60 <sup>+0.3</sup> <sub>-0.2</sub>	38	60	70 ±0.2	0.65
01 021 014	DR-S 38 × 80	30 <sup>+0.25</sup> <sub>0</sub>	60 <sup>+0.3</sup> <sub>-0.2</sub>	38	80	90 ±0.2	0.85
01 021 015	DR-S 38 × 120	30 <sup>+0.25</sup> <sub>0</sub>	60 <sup>+0.3</sup> <sub>-0.2</sub>	38	120	130 ±0.2	1.25
01 021 026	DR-S 45 × 80	35 <sup>+0.4</sup> <sub>0</sub>	75 <sup>+0.3</sup> <sub>-0.2</sub>	45	80	90 ±0.2	1.41
01 021 027	DR-S 45 × 100	35 <sup>+0.4</sup> <sub>0</sub>	75 <sup>+0.3</sup> <sub>-0.2</sub>	45	100	110 ±0.2	1.75
01 021 028	DR-S 45 × 150	35 <sup>+0.4</sup> <sub>0</sub>	75 <sup>+0.3</sup> <sub>-0.2</sub>	45	150	160 ±0.2	2.59
01 021 029	DR-S 50 × 120	40 <sup>+0.4</sup> <sub>0</sub>	80 <sup>+0.3</sup> <sub>-0.2</sub>	50	120	130 ±0.2	2.30
01 021 030	DR-S 50 × 200	40 <sup>+0.4</sup> <sub>0</sub>	80 <sup>+0.3</sup> <sub>-0.2</sub>	50	200	210 ±0.2	3.79
01 021 031	DR-S 50 × 300	40 <sup>+0.4</sup> <sub>0</sub>	80 <sup>+0.3</sup> <sub>-0.2</sub>	50	300	310 ±0.2	5.66

List of torque and loads on page 2.3.

If no other units are specified, the numbers given are in mm.

# Rubber Suspension Element

## Bracket BR

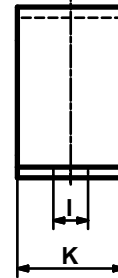
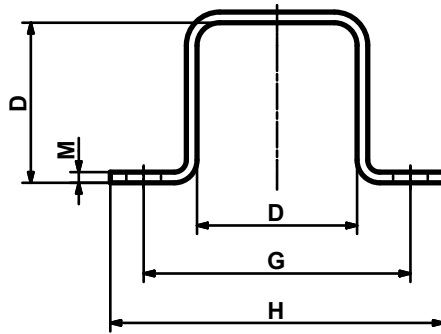

Part no.	Type	D	G	H	ø l	K	M	Weight [kg]
01 500 001	<b>BR 11</b>	20	37	50	6	20	2	0.02
01 500 002	<b>BR 15</b>	27	50	65	7	25	2	0.04
01 500 003	<b>BR 18</b>	32	60	80	9	30	2.5	0.08
01 500 004	<b>BR 27</b>	45	80	105	11	35	3	0.14
01 500 005	<b>BR 38</b>	60	100	125	13	40	4	0.27
01 500 026	<b>BR 45</b>	75	120	150	13	45	5	0.47
01 500 027	<b>BR 50</b>	80	135	175	18	50	6	0.70

If no other units are specified, the numbers given are in mm.



# Rubber Suspension Element

## DK-A

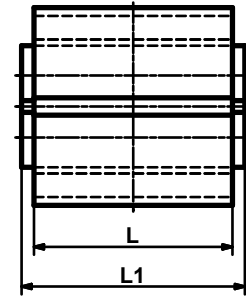
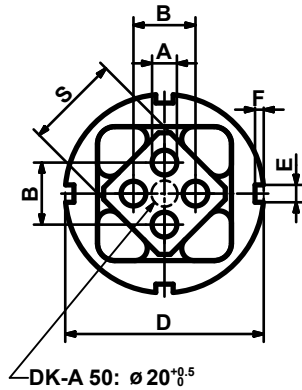

Part no.	Type	$\varnothing A$	B	$\varnothing D$	E	F	$\square S$	L	L1	Weight [kg]
01 071 001	DK-A 15 × 25	$5^{+0.5}_0$	$10_{\pm 0.2}$	$36^{+0.5}_{-0.1}$	5	2.5	15	25	$30^{0}_{-0.3}$	0.05
01 071 002	DK-A 15 × 40	$5^{+0.5}_0$	$10_{\pm 0.2}$	$36^{+0.5}_{-0.1}$	5	2.5	15	40	$45^{0}_{-0.3}$	0.08
01 071 003	DK-A 15 × 60	$5^{+0.5}_0$	$10_{\pm 0.2}$	$36^{+0.5}_{-0.1}$	5	2.5	15	60	$65^{0}_{-0.3}$	0.12
01 071 004	DK-A 18 × 30	$6^{+0.5}_0$	$12_{\pm 0.3}$	$45^{+0.6}_{-0.1}$	5	2.5	18	30	$35^{0}_{-0.3}$	0.10
01 071 005	DK-A 18 × 50	$6^{+0.5}_0$	$12_{\pm 0.3}$	$45^{+0.6}_{-0.1}$	5	2.5	18	50	$55^{0}_{-0.3}$	0.16
01 071 006	DK-A 18 × 80	$6^{+0.5}_0$	$12_{\pm 0.3}$	$45^{+0.6}_{-0.1}$	5	2.5	18	80	$85^{0}_{-0.3}$	0.25
01 071 007	DK-A 27 × 40	$8^{+0.5}_0$	$20_{\pm 0.4}$	$62^{+0.7}_{-0.1}$	6	3	27	40	$45^{0}_{-0.3}$	0.25
01 071 008	DK-A 27 × 60	$8^{+0.5}_0$	$20_{\pm 0.4}$	$62^{+0.7}_{-0.1}$	6	3	27	60	$65^{0}_{-0.3}$	0.37
01 071 009	DK-A 27 × 100	$8^{+0.5}_0$	$20_{\pm 0.4}$	$62^{+0.7}_{-0.1}$	6	3	27	100	$105^{0}_{-0.3}$	0.61
01 071 010	DK-A 38 × 60	$10^{+0.5}_0$	$25_{\pm 0.4}$	$80^{+0.8}_{-0.1}$	7	3.5	38	60	$70^{0}_{-0.3}$	0.62
01 071 011	DK-A 38 × 80	$10^{+0.5}_0$	$25_{\pm 0.4}$	$80^{+0.8}_{-0.1}$	7	3.5	38	80	$90^{0}_{-0.3}$	0.82
01 071 012	DK-A 38 × 120	$10^{+0.5}_0$	$25_{\pm 0.4}$	$80^{+0.8}_{-0.1}$	7	3.5	38	120	$130^{0}_{-0.3}$	1.22
01 071 013	DK-A 45 × 80	$12^{+0.5}_0$	$35_{\pm 0.5}$	$95^{+1.0}_{-0.1}$	8	4	45	80	$90^{0}_{-0.3}$	1.14
01 071 014	DK-A 45 × 100	$12^{+0.5}_0$	$35_{\pm 0.5}$	$95^{+1.0}_{-0.1}$	8	4	45	100	$110^{0}_{-0.3}$	1.41
01 071 015	DK-A 45 × 150	$12^{+0.5}_0$	$35_{\pm 0.5}$	$95^{+1.0}_{-0.1}$	8	4	45	150	$160^{0}_{-0.3}$	2.11
01 071 016	DK-A 50 × 120	M12 × 40	$40_{\pm 0.5}$	$108^{+1.2}_{-0.1}$	8	4	50	120	$130^{0}_{-0.3}$	2.26
01 071 017	DK-A 50 × 200	M12 × 40	$40_{\pm 0.5}$	$108^{+1.2}_{-0.1}$	8	4	50	200	$210^{0}_{-0.3}$	3.74
01 071 018	DK-A 50 × 300	M12 × 40	$40_{\pm 0.5}$	$108^{+1.2}_{-0.1}$	8	4	50	300	$310^{0}_{-0.3}$	5.62

List of torque and loads on page 2.3.

If no other units are specified, the numbers given are in mm.

# Rubber Suspension Element

## DK-S

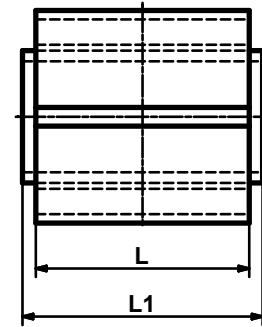
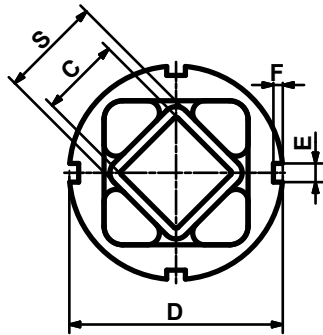
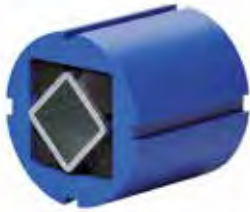

Part no.	Type	□C	∅D	E	F	□S	L	L1	Weight [kg]
01 081 001	DK-S 11 × 20	8 <sup>+0.25</sup> <sub>0</sub>	28 <sup>+0.5</sup> <sub>-0.1</sub>	4	2.5	11	20	25 ±0.2	0.03
01 081 002	DK-S 11 × 30	8 <sup>+0.25</sup> <sub>0</sub>	28 <sup>+0.5</sup> <sub>-0.1</sub>	4	2.5	11	30	35 ±0.2	0.04
01 081 003	DK-S 11 × 50	8 <sup>+0.25</sup> <sub>0</sub>	28 <sup>+0.5</sup> <sub>-0.1</sub>	4	2.5	11	50	55 ±0.2	0.07
01 081 004	DK-S 15 × 25	11 <sup>+0.25</sup> <sub>0</sub>	36 <sup>+0.5</sup> <sub>-0.1</sub>	5	2.5	15	25	30 ±0.2	0.06
01 081 005	DK-S 15 × 40	11 <sup>+0.25</sup> <sub>0</sub>	36 <sup>+0.5</sup> <sub>-0.1</sub>	5	2.5	15	40	45 ±0.2	0.10
01 081 006	DK-S 15 × 60	11 <sup>+0.25</sup> <sub>0</sub>	36 <sup>+0.5</sup> <sub>-0.1</sub>	5	2.5	15	60	65 ±0.2	0.14
01 081 007	DK-S 18 × 30	12 <sup>+0.25</sup> <sub>0</sub>	45 <sup>+0.6</sup> <sub>-0.1</sub>	5	2.5	18	30	35 ±0.2	0.13
01 081 008	DK-S 18 × 50	12 <sup>+0.25</sup> <sub>0</sub>	45 <sup>+0.6</sup> <sub>-0.1</sub>	5	2.5	18	50	55 ±0.2	0.21
01 081 009	DK-S 18 × 80	12 <sup>+0.25</sup> <sub>0</sub>	45 <sup>+0.6</sup> <sub>-0.1</sub>	5	2.5	18	80	85 ±0.2	0.32
01 081 010	DK-S 27 × 40	22 <sup>+0.25</sup> <sub>0</sub>	62 <sup>+0.7</sup> <sub>-0.1</sub>	6	3	27	40	45 ±0.2	0.27
01 081 011	DK-S 27 × 60	22 <sup>+0.25</sup> <sub>0</sub>	62 <sup>+0.7</sup> <sub>-0.1</sub>	6	3	27	60	65 ±0.2	0.40
01 081 012	DK-S 27 × 100	22 <sup>+0.25</sup> <sub>0</sub>	62 <sup>+0.7</sup> <sub>-0.1</sub>	6	3	27	100	105 ±0.2	0.66
01 081 013	DK-S 38 × 60	30 <sup>+0.25</sup> <sub>0</sub>	80 <sup>+0.8</sup> <sub>-0.1</sub>	7	3.5	38	60	70 ±0.2	0.70
01 081 014	DK-S 38 × 80	30 <sup>+0.25</sup> <sub>0</sub>	80 <sup>+0.8</sup> <sub>-0.1</sub>	7	3.5	38	80	90 ±0.2	0.92
01 081 015	DK-S 38 × 120	30 <sup>+0.25</sup> <sub>0</sub>	80 <sup>+0.8</sup> <sub>-0.1</sub>	7	3.5	38	120	130 ±0.2	1.36
01 081 016	DK-S 45 × 80	35 <sup>+0.4</sup> <sub>0</sub>	95 <sup>+1.0</sup> <sub>-0.1</sub>	8	4	45	80	90 ±0.2	1.30
01 081 017	DK-S 45 × 100	35 <sup>+0.4</sup> <sub>0</sub>	95 <sup>+1.0</sup> <sub>-0.1</sub>	8	4	45	100	110 ±0.2	1.65
01 081 018	DK-S 45 × 150	35 <sup>+0.4</sup> <sub>0</sub>	95 <sup>+1.0</sup> <sub>-0.1</sub>	8	4	45	150	160 ±0.2	2.38
01 081 019	DK-S 50 × 120	40 <sup>+0.4</sup> <sub>0</sub>	108 <sup>+1.2</sup> <sub>-0.1</sub>	8	4	50	120	130 ±0.2	2.50
01 081 020	DK-S 50 × 200	40 <sup>+0.4</sup> <sub>0</sub>	108 <sup>+1.2</sup> <sub>-0.1</sub>	8	4	50	200	210 ±0.2	4.14
01 081 021	DK-S 50 × 300	40 <sup>+0.4</sup> <sub>0</sub>	108 <sup>+1.2</sup> <sub>-0.1</sub>	8	4	50	300	310 ±0.2	5.59

List of torque and loads on page 2.3.

If no other units are specified, the numbers given are in mm.

# Rubber Suspension Element

## Bracket BK

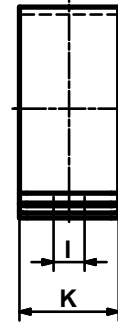
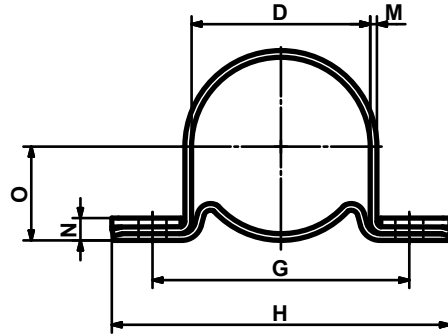

Part no.	Type	D	G	H	$\varnothing I$	K	M	N	O	Weight [kg]
01 520 001	<b>BK 11</b>	28	45	60	6.5	20	1.5	6	15.5	0.05
01 520 002	<b>BK 15</b>	36	55	75	6.5	25	2	7	20.0	0.09
01 520 003	<b>BK 18</b>	45	68	90	8.5	30	2	8	24.5	0.14
01 520 004	<b>BK 27</b>	62	92	125	10.5	35	2.5	10	33.5	0.28
01 520 005	<b>BK 38</b>	80	115	150	12.5	40	3	11	43.0	0.47
01 520 006	<b>BK 45</b>	95	130	165	12.5	45	4	14	51.5	0.77
01 520 007	<b>BK 50</b>	108	152	195	16.5	50	4	15	58.0	1.04

If no other units are specified, the numbers given are in mm.

With the BK bracket, the position of the DK element can be freely selected over 360°.

# Rubber Suspension Element

## DW-A 15 to 50

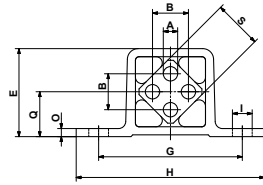

sizes 15 to 50 × 160

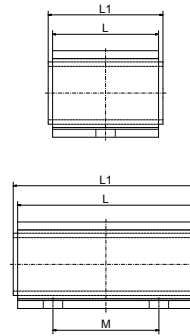

size 50 × 200

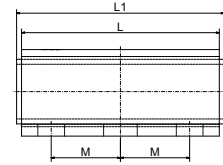

Part no.	Type	∅A	B	E	G	H	∅I	O	Q	□S	L	L1	M	Weight [kg]
01 101 016	DW-A 15 × 25	5 <sup>+0.5</sup> <sub>0</sub>	10 ±0.2	29	50	65	7	3	15	15	25	30 <sup>0</sup> <sub>-0.3</sub>	–	0.04
01 101 017	DW-A 15 × 40	5 <sup>+0.5</sup> <sub>0</sub>	10 ±0.2	29	50	65	7	3	15	15	40	45 <sup>0</sup> <sub>-0.3</sub>	–	0.07
01 101 018	DW-A 15 × 60	5 <sup>+0.5</sup> <sub>0</sub>	10 ±0.2	29	50	65	7	3	15	15	60	65 <sup>0</sup> <sub>-0.3</sub>	40	0.10
01 101 019	DW-A 18 × 30	6 <sup>+0.5</sup> <sub>0</sub>	12 ±0.3	35	60	80	9	3.5	18	18	30	35 <sup>0</sup> <sub>-0.3</sub>	–	0.08
01 101 020	DW-A 18 × 50	6 <sup>+0.5</sup> <sub>0</sub>	12 ±0.3	35	60	80	9	3.5	18	18	50	55 <sup>0</sup> <sub>-0.3</sub>	–	0.13
01 101 021	DW-A 18 × 80	6 <sup>+0.5</sup> <sub>0</sub>	12 ±0.3	35	60	80	9	3.5	18	18	80	85 <sup>0</sup> <sub>-0.3</sub>	50	0.20
01 101 022	DW-A 27 × 40	8 <sup>+0.5</sup> <sub>0</sub>	20 ±0.4	49	80	105	11	4.5	25	27	40	45 <sup>0</sup> <sub>-0.3</sub>	–	0.21
01 101 023	DW-A 27 × 60	8 <sup>+0.5</sup> <sub>0</sub>	20 ±0.4	49	80	105	11	4.5	25	27	60	65 <sup>0</sup> <sub>-0.3</sub>	–	0.31
01 101 024	DW-A 27 × 100	8 <sup>+0.5</sup> <sub>0</sub>	20 ±0.4	49	80	105	11	4.5	25	27	100	105 <sup>0</sup> <sub>-0.3</sub>	60	0.51
01 101 025	DW-A 38 × 60	10 <sup>+0.5</sup> <sub>0</sub>	25 ±0.4	67	100	125	13	6	34	38	60	70 <sup>0</sup> <sub>-0.3</sub>	–	0.57
01 101 026	DW-A 38 × 80	10 <sup>+0.5</sup> <sub>0</sub>	25 ±0.4	67	100	125	13	6	34	38	80	90 <sup>0</sup> <sub>-0.3</sub>	40	0.75
01 101 027	DW-A 38 × 120	10 <sup>+0.5</sup> <sub>0</sub>	25 ±0.4	67	100	125	13	6	34	38	120	130 <sup>0</sup> <sub>-0.3</sub>	80	1.12
01 101 043	DW-A 45 × 80	12 <sup>+0.5</sup> <sub>0</sub>	35 ±0.5	81	115	145	13 × 27	9	41	45	80	90 <sup>0</sup> <sub>-0.3</sub>	–	1.08
01 101 044	DW-A 45 × 100	12 <sup>+0.5</sup> <sub>0</sub>	35 ±0.5	81	115	145	13 × 27	9	41	45	100	110 <sup>0</sup> <sub>-0.3</sub>	58	1.35
01 101 045	DW-A 45 × 150	12 <sup>+0.5</sup> <sub>0</sub>	35 ±0.5	81	115	145	13 × 27	9	41	45	150	160 <sup>0</sup> <sub>-0.3</sub>	90	2.00
01 101 046	DW-A 50 × 120	M12 × 40	40 ±0.5	88	130	170	17 × 27	12	45	50	120	130 <sup>0</sup> <sub>-0.3</sub>	60	1.91
01 101 047	DW-A 50 × 160	M12 × 40	40 ±0.5	88	130	170	17 × 27	12	45	50	160	170 <sup>0</sup> <sub>-0.3</sub>	70	2.57
01 101 048	DW-A 50 × 200	M12 × 40	40 ±0.5	88	130	170	17 × 27	12	45	50	200	210 <sup>0</sup> <sub>-0.3</sub>	70	3.18

List of torque and loads on page 2.3.

If no other units are specified, the numbers given are in mm.

# Rubber Suspension Element

## DW-A 60 to 100

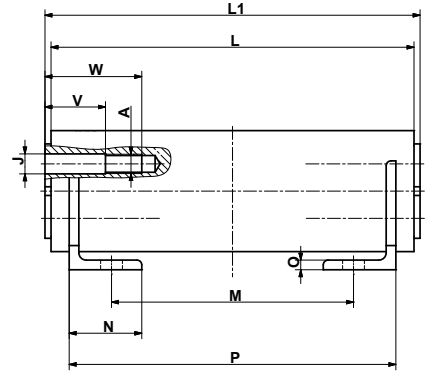
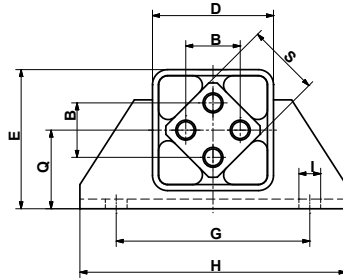

Part no.	Type	A	B	D	E	G	H	øI	øJ	N	O	Q	□S	V	W	L	L1	M	P	Weight [kg]
01 101 031	DW-A 60 × 150	M16	45	100	115	160	220	18	16.5	60	8	65	60	40	70	150	160 ±0.2	60	130	8.74
01 101 032	DW-A 60 × 200	M16	45	100	115	160	220	18	16.5	60	8	65	60	50	80	200	210 ±0.2	100	170	11.10
01 101 033	DW-A 60 × 300	M16	45	100	115	160	220	18	16.5	60	8	65	60	50	80	300	310 ±0.2	200	270	15.90
01 101 034	DW-A 70 × 200	M20	50	120	140	200	260	22	20.5	65	9	80	70	50	90	200	210 ±0.2	100	170	15.87
01 101 035	DW-A 70 × 300	M20	50	120	140	200	260	22	20.5	65	9	80	70	50	90	300	310 ±0.2	200	270	21.70
01 101 036	DW-A 70 × 400	M20	50	120	140	200	260	22	20.5	65	9	80	70	50	90	400	410 ±0.2	300	370	28.20
01 101 037	DW-A 80 × 200	M20	60	136	153	220	280	22	20.5	80	10	85	80	50	90	200	210 ±0.2	80	170	21.70
01 101 038	DW-A 80 × 300	M20	60	136	153	220	280	22	20.5	80	10	85	80	50	90	300	310 ±0.2	180	270	29.40
01 101 039	DW-A 80 × 400	M20	60	136	153	220	280	22	20.5	80	10	85	80	50	90	400	410 ±0.2	280	370	39.40
01 101 040	DW-A 100 × 250	M24	75	170	195	300	380	26	25	100	12	110	100	50	100	250	260 ±0.2	110	220	41.00
01 101 041	DW-A 100 × 400	M24	75	170	195	300	380	26	25	100	12	110	100	50	100	400	410 ±0.2	260	370	64.70
01 101 042	DW-A 100 × 500	M24	75	170	195	300	380	26	25	100	12	110	100	50	100	500	510 ±0.2	360	470	78.70

List of torque and loads on page 2.3.

If no other units are specified, the numbers given are in mm.

# Rubber Suspension Element

## DW-C

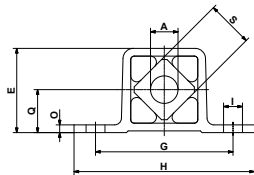
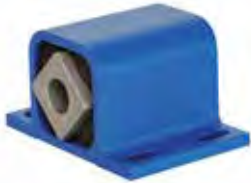

sizes 15 to 50 × 160

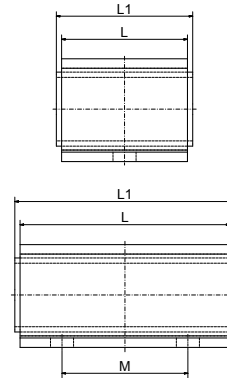

size 50 × 200

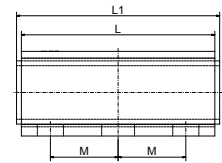

Part no.	Type	$\varnothing A$	E	G	H	$\varnothing I$	O	Q	$\square S$	L	L1	M	Weight [kg]
01 121 101	DW-C 15 × 25	10 <sup>+0.4</sup> <sub>-0.2</sub>	29	50	65	7	3	15	15	25	30 <sup>0</sup> <sub>-0.3</sub>	—	0.05
01 121 102	DW-C 15 × 40	10 <sup>+0.4</sup> <sub>-0.2</sub>	29	50	65	7	3	15	15	40	45 <sup>0</sup> <sub>-0.3</sub>	—	0.07
01 121 103	DW-C 15 × 60	10 <sup>+0.4</sup> <sub>-0.2</sub>	29	50	65	7	3	15	15	60	65 <sup>0</sup> <sub>-0.3</sub>	40	0.11
01 121 104	DW-C 18 × 30	13 <sup>0</sup> <sub>-0.2</sub>	35	60	80	9	3.5	18	18	30	35 <sup>0</sup> <sub>-0.3</sub>	—	0.08
01 121 105	DW-C 18 × 50	13 <sup>0</sup> <sub>-0.2</sub>	35	60	80	9	3.5	18	18	50	55 <sup>0</sup> <sub>-0.3</sub>	—	0.13
01 121 106	DW-C 18 × 80	13 <sup>0</sup> <sub>-0.2</sub>	35	60	80	9	3.5	18	18	80	85 <sup>0</sup> <sub>-0.3</sub>	50	0.20
01 121 107	DW-C 27 × 40	16 <sup>+0.5</sup> <sub>-0.3</sub>	49	80	105	11	4.5	25	27	40	45 <sup>0</sup> <sub>-0.3</sub>	—	0.21
01 121 108	DW-C 27 × 60	16 <sup>+0.5</sup> <sub>-0.3</sub>	49	80	105	11	4.5	25	27	60	65 <sup>0</sup> <sub>-0.3</sub>	—	0.31
01 121 109	DW-C 27 × 100	16 <sup>+0.5</sup> <sub>-0.3</sub>	49	80	105	11	4.5	25	27	100	105 <sup>0</sup> <sub>-0.3</sub>	60	0.50
01 121 110	DW-C 38 × 60	20 <sup>+0.5</sup> <sub>-0.2</sub>	67	100	125	13	6	34	38	60	70 <sup>0</sup> <sub>-0.3</sub>	—	0.58
01 121 111	DW-C 38 × 80	20 <sup>+0.5</sup> <sub>-0.2</sub>	67	100	125	13	6	34	38	80	90 <sup>0</sup> <sub>-0.3</sub>	40	0.76
01 121 112	DW-C 38 × 120	20 <sup>+0.5</sup> <sub>-0.2</sub>	67	100	125	13	6	34	38	120	130 <sup>0</sup> <sub>-0.3</sub>	80	1.13
01 121 113	DW-C 45 × 80	24 <sup>+0.5</sup> <sub>-0.2</sub>	81	115	145	13 × 27	9	41	45	80	90 <sup>0</sup> <sub>-0.3</sub>	—	1.10
01 121 114	DW-C 45 × 100	24 <sup>+0.5</sup> <sub>-0.2</sub>	81	115	145	13 × 27	9	41	45	100	110 <sup>0</sup> <sub>-0.3</sub>	58	1.35
01 121 115	DW-C 45 × 150	24 <sup>+0.5</sup> <sub>-0.2</sub>	81	115	145	13 × 27	9	41	45	150	160 <sup>0</sup> <sub>-0.3</sub>	90	2.00
01 121 116	DW-C 50 × 120	30 <sup>+0.5</sup> <sub>-0.2</sub>	88	130	170	17 × 27	12	45	50	120	130 <sup>0</sup> <sub>-0.3</sub>	60	1.90
01 121 117	DW-C 50 × 160	30 <sup>+0.5</sup> <sub>-0.2</sub>	88	130	170	17 × 27	12	45	50	160	170 <sup>0</sup> <sub>-0.3</sub>	70	2.50
01 121 118	DW-C 50 × 200	30 <sup>+0.5</sup> <sub>-0.2</sub>	88	130	170	17 × 27	12	45	50	200	210 <sup>0</sup> <sub>-0.3</sub>	70	3.10

List of torque and loads on page 2.3.

If no other units are specified, the numbers given are in mm.



# Rubber Suspension Element

## DW-S

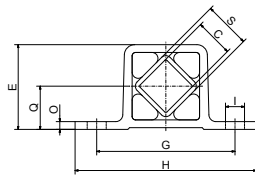

sizes 15 to 50 × 160

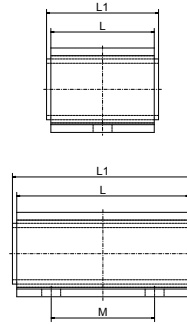

size 50 × 200

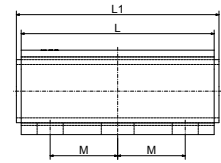

Part no.	Type	□C	E	G	H	∅I	O	Q	□S	L	L1	M	Weight [kg]
01 111 201	DW-S 15 × 25	11 <sup>+0.25</sup> <sub>0</sub>	29	50	65	7	3	15	15	25	30 ±0.2	–	0.06
01 111 202	DW-S 15 × 40	11 <sup>+0.25</sup> <sub>0</sub>	29	50	65	7	3	15	15	40	45 ±0.2	–	0.09
01 111 203	DW-S 15 × 60	11 <sup>+0.25</sup> <sub>0</sub>	29	50	65	7	3	15	15	60	65 ±0.2	40	0.13
01 111 204	DW-S 18 × 30	12 <sup>+0.25</sup> <sub>0</sub>	35	60	80	9	3.5	18	18	30	35 ±0.2	–	0.13
01 111 205	DW-S 18 × 50	12 <sup>+0.25</sup> <sub>0</sub>	35	60	80	9	3.5	18	18	50	55 ±0.2	–	0.11
01 111 206	DW-S 18 × 80	12 <sup>+0.25</sup> <sub>0</sub>	35	60	80	9	3.5	18	18	80	85 ±0.2	50	0.27
01 111 207	DW-S 27 × 40	22 <sup>+0.25</sup> <sub>0</sub>	49	80	105	11	4.5	25	27	40	45 ±0.2	–	0.22
01 111 208	DW-S 27 × 60	22 <sup>+0.25</sup> <sub>0</sub>	49	80	105	11	4.5	25	27	60	65 ±0.2	–	0.33
01 111 209	DW-S 27 × 100	22 <sup>+0.25</sup> <sub>0</sub>	49	80	105	11	4.5	25	27	100	105 ±0.2	60	0.56
01 111 210	DW-S 38 × 60	30 <sup>+0.25</sup> <sub>0</sub>	67	100	125	13	6	34	38	60	70 ±0.2	–	0.65
01 111 211	DW-S 38 × 80	30 <sup>+0.25</sup> <sub>0</sub>	67	100	125	13	6	34	38	80	90 ±0.2	40	0.85
01 111 212	DW-S 38 × 120	30 <sup>+0.25</sup> <sub>0</sub>	67	100	125	13	6	34	38	120	130 ±0.2	80	1.27
01 111 213	DW-S 45 × 80	35 <sup>+0.4</sup> <sub>0</sub>	81	115	145	13 × 27	9	41	45	80	90 ±0.2	–	1.26
01 111 214	DW-S 45 × 100	35 <sup>+0.4</sup> <sub>0</sub>	81	115	145	13 × 27	9	41	45	100	110 ±0.2	58	1.60
01 111 215	DW-S 45 × 150	35 <sup>+0.4</sup> <sub>0</sub>	81	115	145	13 × 27	9	41	45	150	160 ±0.2	90	2.30
01 111 216	DW-S 50 × 120	40 <sup>+0.4</sup> <sub>0</sub>	88	130	170	17 × 27	12	45	50	120	130 ±0.2	60	2.16
01 111 217	DW-S 50 × 160	40 <sup>+0.4</sup> <sub>0</sub>	88	130	170	17 × 27	12	45	50	160	170 ±0.2	70	2.87
01 111 218	DW-S 50 × 200	40 <sup>+0.4</sup> <sub>0</sub>	88	130	170	17 × 27	12	45	50	200	210 ±0.2	70	3.55

List of torque and loads on page 2.3.

If no other units are specified, the numbers given are in mm.

# Rubber Suspension Element

## DO-A



sizes 15 to 45

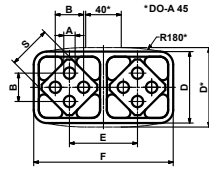

sizes 15 to 45

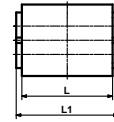

size 50

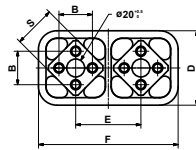

size 50

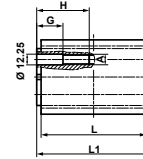

Part no.	Type	$\varnothing A$	B	D	E	F	$\square S$	G	H	L	L1	Weight [kg]
01 041 001	DO-A 15 × 25	5 <sup>+0.5</sup> <sub>0</sub>	10 ±0.2	28	25.5	53.5	15	–	–	25	30 <sup>0</sup> <sub>-0.3</sub>	0.07
01 041 002	DO-A 15 × 40	5 <sup>+0.5</sup> <sub>0</sub>	10 ±0.2	28	25.5	53.5	15	–	–	40	45 <sup>0</sup> <sub>-0.3</sub>	0.11
01 041 003	DO-A 15 × 60	5 <sup>+0.5</sup> <sub>0</sub>	10 ±0.2	28	25.5	53.5	15	–	–	60	65 <sup>0</sup> <sub>-0.3</sub>	0.15
01 041 004	DO-A 18 × 30	6 <sup>+0.5</sup> <sub>0</sub>	12 ±0.3	34	31	65	18	–	–	30	35 <sup>0</sup> <sub>-0.3</sub>	0.12
01 041 005	DO-A 18 × 50	6 <sup>+0.5</sup> <sub>0</sub>	12 ±0.3	34	31	65	18	–	–	50	55 <sup>0</sup> <sub>-0.3</sub>	0.20
01 041 006	DO-A 18 × 80	6 <sup>+0.5</sup> <sub>0</sub>	12 ±0.3	34	31	65	18	–	–	80	85 <sup>0</sup> <sub>-0.3</sub>	0.31
01 041 007	DO-A 27 × 40	8 <sup>+0.5</sup> <sub>0</sub>	20 ±0.4	47	44	91	27	–	–	40	45 <sup>0</sup> <sub>-0.3</sub>	0.32
01 041 008	DO-A 27 × 60	8 <sup>+0.5</sup> <sub>0</sub>	20 ±0.4	47	44	91	27	–	–	60	65 <sup>0</sup> <sub>-0.3</sub>	0.47
01 041 009	DO-A 27 × 100	8 <sup>+0.5</sup> <sub>0</sub>	20 ±0.4	47	44	91	27	–	–	100	105 <sup>0</sup> <sub>-0.3</sub>	0.76
01 041 010	DO-A 38 × 60	10 <sup>+0.5</sup> <sub>0</sub>	25 ±0.4	63	60	123	38	–	–	60	70 <sup>0</sup> <sub>-0.3</sub>	0.88
01 041 011	DO-A 38 × 80	10 <sup>+0.5</sup> <sub>0</sub>	25 ±0.4	63	60	123	38	–	–	80	90 <sup>0</sup> <sub>-0.3</sub>	1.14
01 041 012	DO-A 38 × 120	10 <sup>+0.5</sup> <sub>0</sub>	25 ±0.4	63	60	123	38	–	–	120	130 <sup>0</sup> <sub>-0.3</sub>	1.69
01 041 013	DO-A 45 × 80	12 <sup>+0.5</sup> <sub>0</sub>	35 ±0.5	85	73	150	45	–	–	80	90 <sup>0</sup> <sub>-0.3</sub>	1.84
01 041 014	DO-A 45 × 100	12 <sup>+0.5</sup> <sub>0</sub>	35 ±0.5	85	73	150	45	–	–	100	110 <sup>0</sup> <sub>-0.3</sub>	2.27
01 041 015	DO-A 45 × 150	12 <sup>+0.5</sup> <sub>0</sub>	35 ±0.5	85	73	150	45	–	–	150	160 <sup>0</sup> <sub>-0.3</sub>	3.37
01 041 026	DO-A 50 × 120	M12	40 ±0.5	89	78	167	50	30	60	120	130 <sup>0</sup> <sub>-0.3</sub>	3.30
01 041 029	DO-A 50 × 160	M12	40 ±0.5	89	78	167	50	30	60	160	170 <sup>0</sup> <sub>-0.3</sub>	4.40
01 041 027	DO-A 50 × 200	M12	40 ±0.5	89	78	167	50	40	70	200	210 <sup>0</sup> <sub>-0.3</sub>	5.50

List of torque and loads on page 2.3.

If no other units are specified, the numbers given are in mm.

Material structure: DO-A 50 available with nodular cast iron housings on request

# Rubber Suspension Element

## Bracket WS

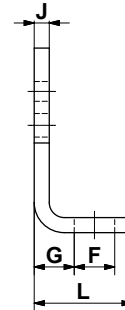
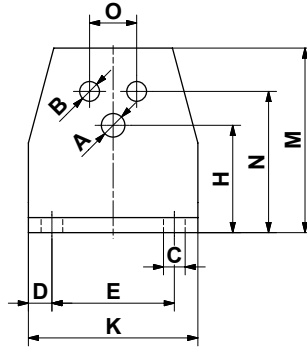

Part no.	Type	Fit for tensioner devices			Fit for DR-A, DK-A, DW-A														Weight [kg]
		SE nominal size	ø A	H	Element nominal size	øB	N	O	C	D	E	F	G	J	K	L	M		
06 590 001	WS 11-15	11	6.5	27	15	5.5	35	10	7	7.5	30	13	11.5	4	45	30	46	0.08	
06 590 002	WS 15-18	15	8.5	34	18	6.5	44	12	7	7.5	40	13	13.5	5	55	32	58	0.15	
06 590 003	WS 18-27	18	10.5	43	27	8.5	55	20	9.5	10	50	15.5	16.5	6	70	38	74	0.30	
06 590 004	WS 27-38	27	12.5	57	38	10.5	75	25	11.5	12.5	65	21.5	21	8	90	52	98	0.66	
06 590 005	WS 38-45	38	16.5	66	45	12.5	85	35	14	15	80	24	21	8	110	55	116	0.94	
06 590 006	WS 45-50	45	20.5	80	50	12.5	110	40	18	20	100	30	26	10	140	66	140	1.74	

If no other units are specified, the numbers given are in mm.



# RUBBER SUSPENSION ELEMENTS

## Torsion-elastic spring assemblies for contemporary engineering and design

- Pendulum suspensions for unbalanced motors
- Torque supports for gear motors
- Torsional springs for continuous surface pressure
- Fully customized rubber suspensions available in exclusive design upon request
- Torsion elastic mounts offering constant pressure on workparts (infeed devices)
- Energy absorbing impact suspensions

### Product advantages:



long service life

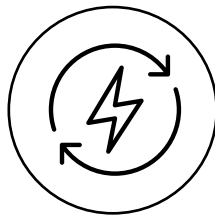

energy-saving

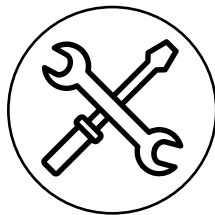

easy to install

# RUBBER SUSPENSION ELEMENTS





# Rubber suspension elements

## Description of inner squares



**A**  
Suitable for alternating deflection via the element rest position. Nominal sizes 15 to 45: Fastening with 2 to 4 continuous screws (of which nominal sizes 27 to 45 with threads are available).

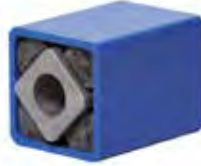

**C**  
Attachment with central screw for frictional connection with 360° adjustment. For optimum frictional connection, please remove the paint on the front side. Alternating deflection up to max.  $\pm 10^\circ$ .



**S**  
For plug-in connections, select plug-in length at least  $2 \times$  light dimension «C». The inserted square must be blank, with a tolerance of h9 to h11. The corners may be over-rotating, the inner radius is max. 1.5 mm). Up to nominal size 18, a frictional connection can be made with one screw. No reciprocal deflection over the element zero position.

## Serial and parallel connection

### Serial connection

Double oscillating angle ( $\pm 60^\circ$ ) with a constant torque.

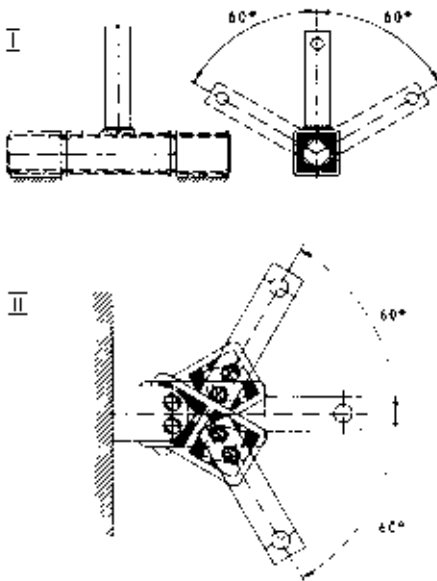

### Parallel connection

Double torque at constant oscillating angle ( $\pm 30^\circ$ ).

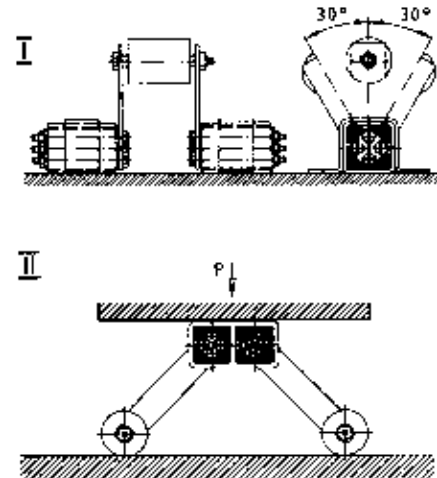

# Rubber suspension elements

## Examples of fixations

### Housing



Outer tube with bracket BR



Plug-in connection

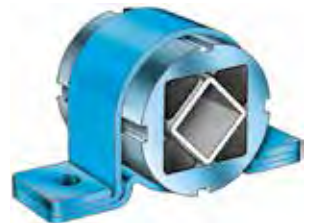

Round housing with bracket BK



Outer housing in clamping jaw

### Inner Square Section

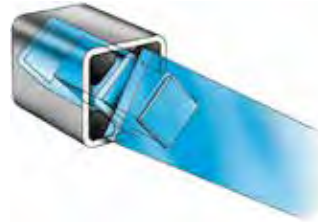

Plug-in connections: inner square made of tubular steel, lever arm with welded-on square profile

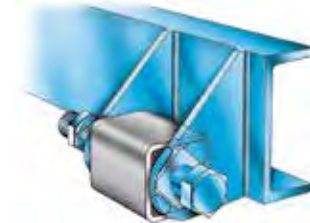

Inner square section with a central through bore



Inner square with through holes and bolted-on lever arm



Inner square with through holes and brackets WS

# Rubber suspension elements

## Application examples

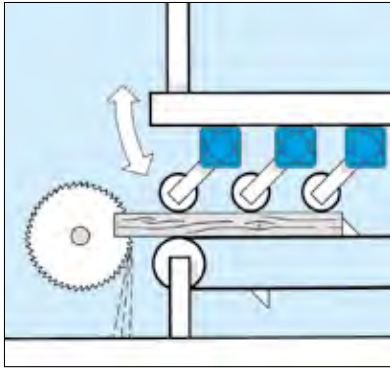

Pressure rollers in saw device

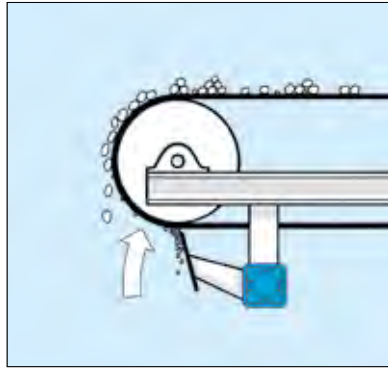

Conveyor-belt scraper

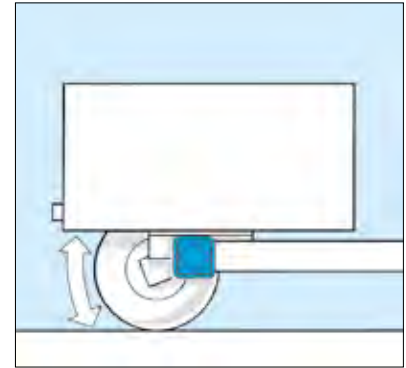

Independent wheel suspension

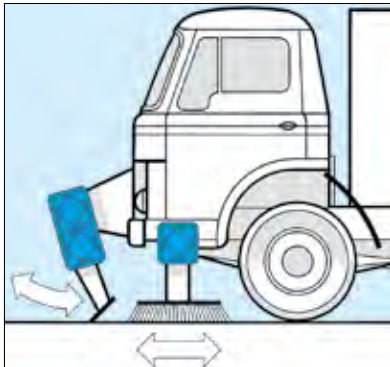

Elastic scraper / brushing joint

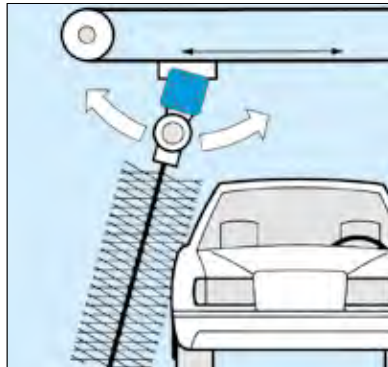

Self-aligning bearing for cleaning brushes

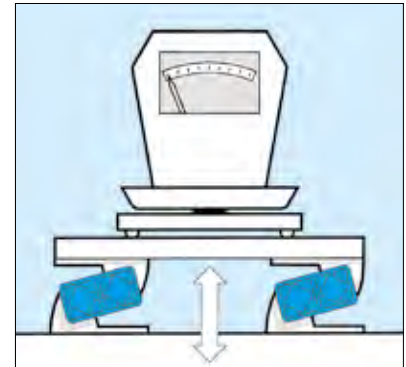

Passive insulation

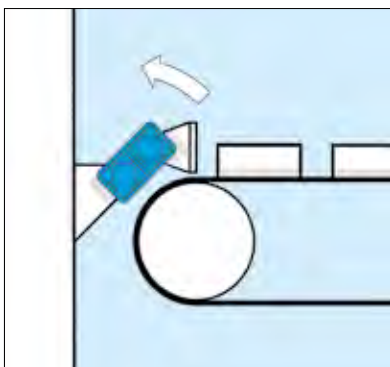

Shock absorber

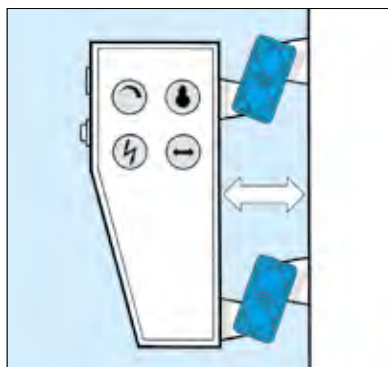

Control unit insulation

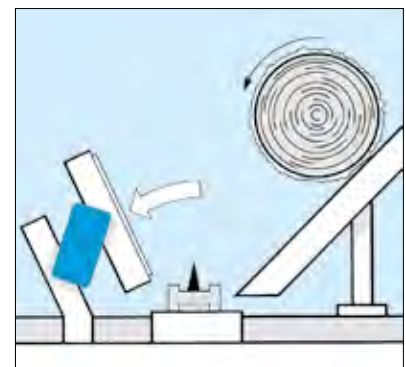

Impact suspension in feeder